

USER MANUAL

Type UCCG, UCDG

Product program

This user manual covers following thermostats with built-in GFCI

UCCG-9991 Incl. floor sensor 3m

UCCG-9999 With built-in room sensor

UCDG-9999 With 2 sensors; built-in room sensor and incl. floor sensor 3m

Introduction

The thermostat is an electronic on/off thermostat for control of temperature by means of an NTC sensor either placed externally or internally in the thermostat. The thermostat has integrated a Ground Fault Circuit Interrupter (GFCI, Class A). The thermostat and the GFCI is a dual model suitable for 120/240 V 50/60 Hz supply.

The thermostat is capable of switching on your heating system at pre determined times on different days of the week. It is possible to set 4 periods called events each day with different temperatures. From factory a default schedule is programmed suitable for most installations. Unless you change these settings the thermostat will operate to this default program. Working with lower temperatures during times that the room is unoccupied will lower your energy costs without reducing the comfort. The thermostat has an adaptive function that automatically changes the start time of a heating period so that the desired temperature is reached at the time that you set. After 5 days the adaptive function has learned when the heating must be switched on.

The thermostat type UCCG-9991 has an external temperature sensor that is normally placed in the floor construction. In this configuration the thermostat controls the temperature of the floor and not the temperature within the room.

The thermostat type UCCG-9999 has a built-in temperature sensor. In this configuration the thermostat controls the temperature of the room.

The thermostat type UCDG-9999 has a built-in temperature sensor and an externally temperature sensor. In this configuration the thermostat controls the temperature within the room and use the externally temperature sensor as limit sensor avoiding too high or too low temperatures in the floor construction.

The thermostat has a pin button marked R, allowing you to reset the thermostat to factory settings. These are listed at the end of this manual with space for you to record your own weekly schedule.

1. Getting started

Buttons

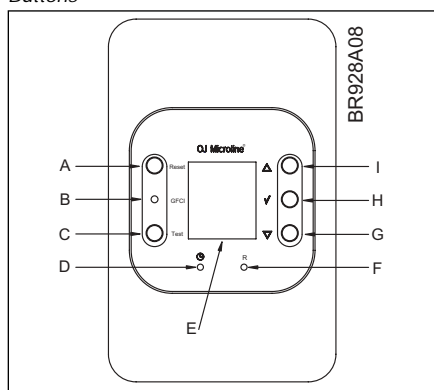

- A:** Reset of GFCI
- B:** Red light indicating ground fault
- C:** Test of GFCI

- D:** Pin button adjust of clock
- E:** Display
- F:** Reset to factory setting
- G:** Adjustment down
- H:** OK - accept
- I:** Adjustment up

Display symbols

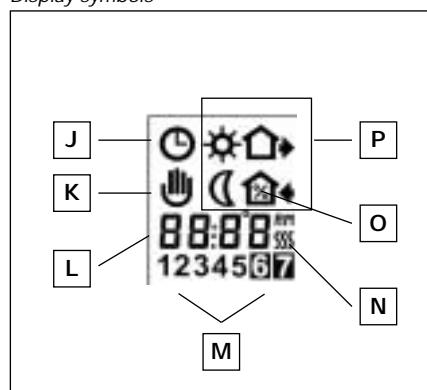

- J:** Clock function
- K:** Manual mode
- L:** Time and temperature
- M:** Day number

- N:** Heating on
- O:** % Monitoring of switch-on time
- P:** 4-event symbol:
 - Wake
 - Night
 - Out
 - Home

Setting the thermostat into operation

First time power is connected the clock and day will be flashing and must be set. After setting of time and day, selection of time scale (12 h or 24 h) and temperature scale (°C or °F) can be selected. If you need to adjust the time of the thermostat at a later date, insert a pin into the hole (Ⓡ) for setting of time and day. Adjustment must be made for summer and winter time. Setting of time and temperature scale can also be done under "advanced settings and read-out see 4.

		Press the UP (Δ) or DOWN (∇) buttons to select the correct time and press OK button (✓).	
		Then press the UP (Δ) or DOWN (∇) button to select the correct day and press OK (✓) button.	1-7
		Press the UP (Δ) button to select time and temperature scale and press OK (✓) button.	

Checking GFCI

It is important that the GFCI has been checked for correct installation and function.

To check the GFCI: Testing can only be performed if the thermostat has a heating demand. Adjust the set point until the heating symbol (SSS) appears, use the (Δ), to increase the heating demand. Wait 10 secs. to let the thermostat work according to the new set point. Press the button "TEST". The test is conclusive if the red light on the thermostat lightens, and the display signs disappear. If this does not occur, check the installation. Press on RESET button to reset the GFCI. The red light should disappear and the display will return to normal appearance. Push ok accept button (✓) to cancel the previously set temperature. If the test fails, check your heating cable and the thermostat. The GFCI test should be carried out monthly.

If the GFCI trips in normal operation, without pressing the TEST button, there could be a ground fault! To check whether it is a ground fault or a nuisance tripping, press RESET. If this cause the red light to shot off and not comes on again, it was a nuisance tripping and the system is functioning. If this cannot be done there is a ground fault! Check your heating cable, the sensor cable and the thermostat. Exchange the defective part.



2. Daily use of the thermostat

4-event clock mode

The day has been split into 4 events describing a typical day. When the thermostat is in 4-event mode it will automatically adjust the temperature according to the required temperature to the required time. As standard the thermostat has 5 days with 4 events, and 2 days with 2 events. Programming see 3.

4-event clock mode:		The clock function symbol (⌚) and one of the 4-event symbols (☀️ 🌙 🏠 🚿) will be indicated. Programming see 3.
Comfort mode: ☞ Δ ∇ ⏸ 5 secs.		Temporary override To temporarily override the temperature in the 4-event schedule program, press the UP (Δ) or DOWN (∇) button once, to show the temperature, and press again to increase or decrease the temperature. The display will flash for 5 seconds, and will then revert to the time. The override will operate until the next programmed event when the unit will resume the automatic programme.
☞ ✓ ✓		Cancel comfort mode To cancel the override state, press the OK (✓) button twice.
Manual mode: ☞ ✓ Δ ∇ ⏸ 5 secs.		Permanent override: During holidays, the scheduled 4-event program can be overridden. Press the OK (✓) button, and then the UP (Δ) or DOWN (∇) button until the override temperature is set. The unit will now operate to this temperature permanently.
☞ ✓		Cancel manual mode To cancel the permanent override state press the OK (✓) button once, and the unit will resume automatic function.

3. Programming

4-event time and temperature

For each event, the start time and required temperature must be set.

For example, in the morning you wish the heating to start at 07:00 and the temperature to rise to 25°C. Press OK (✓) button for 3 seconds and the start time is displayed. Change this to 07:00 with the UP (Δ) or DOWN (∇) button. Press OK (✓) to confirm. The temperature is now displayed. Change this to 25°C with the UP (Δ) or DOWN (∇) button. Press OK (✓) button to confirm. This action can now be repeated for the second event.

These settings will be valid with days 1-5 showing on the display. To program the days 6 and 7, repeat the above. Days 6 and 7 are usually Saturday and Sunday, and only have two events.

The temperature can be set within the range of +5 to +40°C. It is also possible to select the heating OFF at that event by reducing the setting to 5°C, and then pressing the (∇) once more.

Press OK (✓) button for 3 secs. to begin programming		
Day 1 - 5		
	☞ Δ ∇ ✓	
		⚙️ : Time and temperature
	☞ Δ ∇ ✓	
		🏠 : Time and temperature
	☞ Δ ∇ ✓	
		🏠 : Time and temperature
	☞ Δ ∇ ✓	
		🌙 : Time and temperature
Day 6 - 7		
	☞ Δ ∇ ✓	
		⚙️ : Time and temperature
	☞ Δ ∇ ✓	
		🌙 : Time and temperature







4. Advanced settings and read-out

	<p>Press both UP (Δ) and DOWN (∇) buttons together for 3 seconds. INFO is displayed. Press UP (Δ) button until you reach the desired sub menu. Select the sub menu with the OK (✓) button.</p>
	<p>Monitoring of energy consumption. The thermostat calculates average time it has been switched on allowing you to monitor your energy consumption. In the thermostat you can read out: Total switch-on time in percentage in the latest 2 days, 30 days or 365 days. Calculation of operational costs per day: (switch-on time:100) x kW x kWh-price x 24 h per day Example: Read-out: 30 % in the latest 365 days Size of heating system: 1,2 kW (ask the installer) Cost of power: 0,2 USD/ kWh - Calculation: (30:100) x 1,2 kW x 0,2 USD/ kWh x 24 h = 1,7 USDper day</p>
	<div style="display: flex; align-items: center;"> <div style="margin-right: 20px;"> <p>2 days</p> <p>30 days</p> <p>365 days</p> <p>Software version</p> <p>Actual sensor temperature</p> </div> <div style="margin-right: 20px;"> </div> <div style="margin-right: 20px;"> </div> <div> <p>Press UP (Δ) or DOWN (∇) button to show the different readouts. No changes can be made here. Use the OK (✓) button to end.</p> </div> </div>
	<p>4-event sequence. The present event sequence flashes: Days 1-5, followed by days 6-7. To change, press the UP (Δ) button until you have days 1-6 and then day 7 flashing, or all 7 days are flashing. Select the required sequence with the OK (✓) button.</p>
	<div style="display: flex; align-items: center;"> <div style="margin-right: 20px;"> </div> <div style="margin-right: 20px;"> </div> <div> <p>5-2: 4 events in 5 days + 2 events in 2 days.</p> <p>6-1: 4 events in 6 days + 2 events in 1 day</p> <p>7-0: 4 events in 7 days</p> </div> </div>
	<p>Max and min allowed temperature range. The temperature setting range of +5° to 40° C can be limited to prevent a too high or too low temperature being selected. For example, a wood floor covering should not be allowed to exceed a maximum of 27° C. Low limitation is used where the temperature of the floor is required never to fall below the minimum set temperature.</p>
	<div style="display: flex; align-items: center;"> <div style="margin-right: 20px;"> <p>40.0°C</p> <p>LoLi</p> <p>5.0°C</p> </div> <div style="margin-right: 20px;"> </div> <div style="margin-right: 20px;"> </div> <div> <p>Maximum allowed temperature setting. Use the UP (Δ) or DOWN (∇) button to increase or reduce, and OK (✓) button to accept.</p> <p>Next is displayed LoLi. Press OK (✓) button to continue.</p> <p>Minimum allowed temperature setting. Use the UP (Δ) or DOWN (∇) button to increase or reduce and OK (✓) button to accept.</p> </div> </div>
	<p>Time and temperature scale selection</p>
	<div style="display: flex; align-items: center;"> <div style="margin-right: 20px;"> </div> <div style="margin-right: 20px;"> </div> <div> <p>You can select either °C or °F scale, and 12 or 24 hour clock as follows: Press UP (Δ) or DOWN (∇) button to change settings. Confirm the required scale with the OK button (✓) button.</p> </div> </div>
	<p>Adaptive function: This function enables the thermostat to calculate when it needs to switch ON so that the required temperature is reached at the set time. With a start time of 07:00 therefore, the thermostat may switch ON as early as 06:00 so that the desired temperature of 25°C is achieved by 07:00. Without this function set, the thermostat will start to heat at the time you set.</p>
	<div style="display: flex; align-items: center;"> <div style="margin-right: 20px;"> <p>ON</p> <p>OFF</p> </div> <div style="margin-right: 20px;"> </div> <div style="margin-right: 20px;"> </div> <div> <p>Press the DOWN (∇) button to switch between on and off. Press OK (✓) button to confirm.</p> </div> </div>
	<div style="display: flex; align-items: center;"> <div style="margin-right: 20px;"> </div> <div> <p>Press OK (✓) button to end programming and to return to scheduled programme.</p> </div> </div>

5. Reset to factory setting

	Press the pin button for 3 secs. and the thermostat returns to factory settings. Time, day and scale for time (12h, 24h) and temperature (F, °C) read-out are also reset and must be set according to "Setting the thermostat into operation".
---	--

Factory settings

4-event time and temperature					
Day 1-5	Time		With floor sensor	Built-in sensor	
	06:00		77°F / 25°C	68°F / 20°C	
	08:00		68°F / 20°C	59°F / 15°C	
	16:00		81°F / 27°C	72°F / 22°C	
	22:30		68°F / 20°C	59°F / 15°C	
Day 6-7					
	08:00		81°F / 27°C	72°F / 22°C	
	23:00		68°F / 20°C	59°F / 15°C	
4-event sequence	5:2				
Hi-Low temp.	131°F / 41°F				
Scale	24 H / °F				
Adaptive control	ON				

6. Failure codes

- E0 = Internal failure, replace thermostat
- E1 = Built-in sensor short-circuit or disconnected, replace thermostat
- E2 = External sensor short-circuit or disconnected

7. Technical data

Supply: 120/240 Vac 50/60 Hz
 Load: 16A maximum (resistive load)
 Power: 1.920 W at 120 Vac
 3.840 W at 240 Vac
 GFCI: Class A (5 mA trip level)
 Temperature range: +5 to +40°C, +40 to +104°F
 Amb. Temperature range:
 Thermostat: 0 to +40°C, +32 to +104°F
 GFCI: -35 to +65°C, -31 to +149°F

OJ ELECTRONICS A/S

Stenager 13B · DK-6400 Sønderborg
 Tel. +45 73 12 13 14 · Fax +45 73 12 13 13
 www.oj.dk